

DOWNLIGHT

DL225

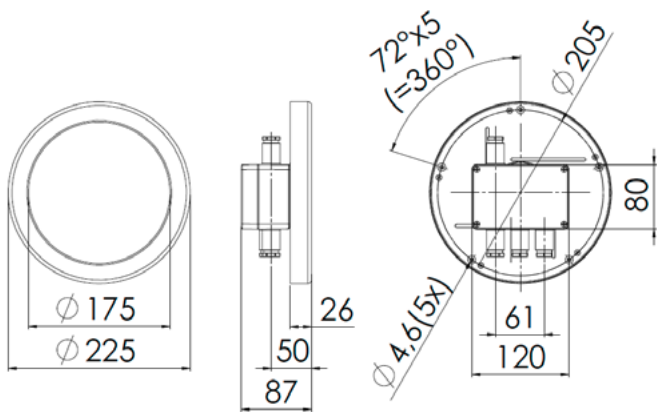

FLAT SURFACE DOWNLIGHT WITH CHANGEABLE COVER RING FOR CABINS AND ACCOMMODATION AREAS









[mm]

MB6.303.0001.00

STANDARD CONFIGURATION

Housing	Polycarbonate
Cover	White ring with opal polycarbonate lens
Mounting	5 holes, Ø 4.6 mm
Connection type	Max. 4 cable glands
Protection class	IP20
Light source	LED array
Wattage	Max. 20W
Luminous flux	1,050 lm
CCT (color)	2,700 K
CRI	≥ 80

AVAILABLE FEATURES

	EMI proof
	Shock proof
	Vibration resistant
	NVG compatible
	Adaptation light
	Multi-circuit

YOUR REQUIREMENTS

Please contact us for different configurations or further information on this luminaire type. Based on your requirements, the final part number will be provided.

Technical modification reserved without prior notice.



LIGHTPARTNER LICHTSYSTEME GMBH & CO. KG
AM MOHRENSHOF 7 · 28277 BREMEN · GERMANY
+49 (0)421 - 87 195 - 0 · SALES@LIGHTPARTNER.DE

LIGHTPARTNER NAVY