

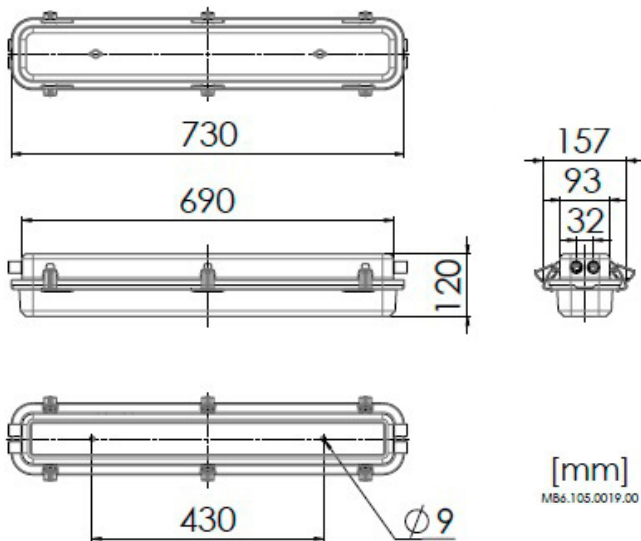







MULTIPURPOSE WATERTIGHT LUMINAIRE FOR MACHINERY SPACES, WORKSHOPS, STORES, CORRIDORS AND OPEN DECKS



## STANDARD CONFIGURATION

Housing	Galvanized or stainless steel, seamless deep drawn, powder coated white (RAL9016)
Cover	Clear or opal polycarbonate, impact-proof, UV resistant
Mounting	M8 bolts
Cable entry	Max. 4 cable glands
Protection class	IP67
Light source	Linear LP LED modules with anti-glare cover
Wattage	max. 20W
Luminous flux	2,200 lm
CCT (color)	4,000 K
CRI	≥ 80

## AVAILABLE FEATURES

	EMI proof
	Shock proof
	Vibration resistant
	NVG compatible
	Adaptation light
	Multi-circuit
	Various optics
	Controllable

## YOUR REQUIREMENTS

Please contact us for different configurations or further information on this luminaire type. Based on your requirements, the final part number will be provided.

Technical modification reserved without prior notice.

